

Coax Clarifier™

Test. Identify. Qualify.

User Manual

Coax Run Mapping

Maps runs through splitters to show an accurate picture of the coax system layout using up to 4 Coax RF Remotes. Up to 12 ID Only Coax Remotes also available for wiremapping on home runs.

Cable Length

Determines cable run length and reports the location of an open or unterminated cable.

Quality of Network

Measures overall network quality and clearly depicts network reading as both a bar graph and a digital return loss number, measured in dB.

Tone Tracing

Traces coax runs with four unique tones to quickly distinguish between respective outlets.



Coax Clarifier™

Test. Identify. Qualify.

TABLE OF CONTENTS

About this Manual.....	1
Symbols and Icons.....	2
Terms and Descriptions.....	3
Safety Information.....	4
Accessories.....	4
Design Features.....	6
CoaxClarifier™ Description.....	7
F-Connector.....	7
LCD Display Screen.....	8
Keypad.....	14
Operations.....	16
Turning the Unit On/Off.....	16
Automatic Power Down.....	16
Cable Testing General Guidelines.....	17
Using Tone Mode.....	18
Trace Cable Runs.....	18
Measure Network Insertion Loss.....	19
Prepare Test Unit.....	19
Calibrate dB Loss Meter.....	20
Measure Network Insertion Loss.....	21
Test Splitters.....	21
Using Length Mode.....	22
Measure Cable Length.....	22
Adjust Length Constant Value.....	24
Length Constant Accuracy.....	26
Using ID Mode.....	27
RF Remote Battery Life.....	29
Using Quality Mode.....	29
RF Remotes and Network Quality.....	30
Measure Network Quality.....	30
Maintenance.....	32
Coax Clarifier™ Battery Replacement.....	32
RF Remote Battery Replacement.....	32
Cleaning.....	33
Storage.....	33
Customer Service.....	34
Contacting T3 Innovation.....	34
Additional Accessories and Kits.....	34
Warranty Information.....	37
Product Registration.....	37
Disposal.....	37
Returns.....	37
Specifications.....	38

ABOUT THIS MANUAL



The Coax Clarifier™ is a self contained, hand-held, battery powered analyzer used by contractors, repair technicians, and other authorized users. This device is used to quickly map coax cable runs, measure network performance, determine cable length, and locate faults in “Dark” (unpowered) residential and business cable networks. The test unit offers the following features:

Feature	Function
Length Testing	Determines cable length and reports distance to an open (unterminated) cable.
Coax Run Mapping	Identifies cables and determines their location by mapping up to 4 runs through a splitter using Coax RF remotes and up to 12 cables using ID Only Coax remotes.
Quality Testing	Measures overall network quality and clearly depicts network reading as both a bar graph and a digital return loss number, measured in decibels (dB).
Tone Tracing	Traces coax runs, with the use of a tone probe, using four tones to easily distinguish between cable outlets and quickly map the network layout.
Insertion Loss	Measures the insertion loss of a single coax run.
Fault Detection	Identifies Open and Short cable faults.

Symbols & Icons

The following symbols are used throughout the manual or in the display screen of the Coax Clarifier™ to help you avoid personal injury and potential damage to the test equipment (see Table 1).

Table 1. Symbols and Icons

Symbol	Definition
	Warning: Potential for personal injury Caution: Potential for damage or destruction to equipment.
Voltage!	Voltage detection symbol. Immediately disconnect test unit from source of voltage.
Act Sig	If an active signal is detected, immediately disconnect test unit from active signal source. If the unit is not disconnected from the source, the Coax Clarifier™ will turn off after 90 seconds.
	Conformité Européenne. Conforms with European Economic Area directives.
	Disposal information.

Terms and Descriptions

Table 2 defines the terms used throughout the manual and provides information to assist you with proper operation and understanding of the unit and its functions.



Table 2. Terms and Descriptions

Terms	Description and Uses
Coax Cable	Video cable with a single pair (2 pin) wiring system. <ul style="list-style-type: none">▪ Common coax cable types are RG6 and RG59.
Run	An end-to-end cable connection. Run can refer to a single cable or multiple cables connected together with a splitter or barrel connector.
Coax Network	Multiple coax cables connected by splitters or home run configurations to concentration panels.
Length Constant Value	The amount of capacitance in picofarads (pF) per unit distance.
Insertion Loss	A measurement of the network's ability to carry a signal from a power source to a receiver at the opposing end of a run. Network insertion loss is measured in dB and represents the percentage of signal that is successfully transmitted through a run.
Return Loss	A common measurement of coax networks, return loss is a measure of Voltage Standing Wave Ratio (VSWR), expressed in dB. It ranges from 0.0 dB for a cable with a dead short to infinity for a perfect cable with absolutely no signal loss. <ul style="list-style-type: none">▪ The Coax Clarifier™ reports the return loss value from 0.0 dB to 40.0 dB, with 40.0 being the best possible network quality.
Splitter	A device used to route a single signal source to two or more devices.
F-Connector	Connector for a coax cable.

Safety Information

To ensure safe operation of the Coax Clarifier™, follow the instructions carefully and observe the warning and caution messages listed in Table 3. Failure to observe warnings can result in severe injury or death and can damage the unit.





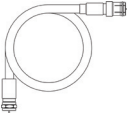



Table 3. Safety Information

Notification	Definition
	The Coax Clarifier™ is designed for use on unenergized cabling systems. Connecting the Coax Clarifier™ to live AC power may damage the unit and pose a safety hazard for the user.
	Do not place equipment or its accessories in the trash. Items must be properly disposed in accordance with local regulations.

ACCESSORIES

The accessories listed in Table 4 are used with the Coax Clarifier™ to identify runs and test coax networks. The provided accessories are dependent on the kit you purchased. The **Additional Accessories and Kits** section contains a detailed list of each kit as well as additional products that can help make testing easier.

Table 4. Coax Clarifier™ Accessories

Accessory	Product Number	Description
	AD002	Adapter, F-Jack to BNC Jack
	AD003	Adapter, F-Jack to Push-On Cable
	AD004	F-Connector Coupler, F81
	AD005	F-Terminator Plug
	CA004	Cable Assembly, Screw-On F-Jack to Push-On F-Plug Cable – 12”
	CR001 CR002 CR003 CR004	<p>Coax RF Remotes</p> <ul style="list-style-type: none"> ▪ No. 1 Coax RF Remote ▪ No. 2 Coax RF Remote ▪ No. 3 Coax RF Remote ▪ No. 4 Coax RF Remote
	RK104 RK112	<p>ID Only Coax Remotes</p> <ul style="list-style-type: none"> ▪ Nos. 1 – 4 ID Only Coax Remote Set in Foam Holder ▪ Nos. 1-12 ID Only Coax Remote Set in Foam Holder (Illustrated)
	TP200	TrakAll Tone Probe

Note: All accessories listed in Table 4 are available for purchase through T3 Innovation. Refer to the **Customer Service** section for contact information.

DESIGN FEATURES

- Easy to operate
- One pass coax cable run mapping
- Tests through splitters
- Identifies open (unterminated) cables
- Extra large seven-segment, backlight LCD screen with icons that clearly display test results
- Displays coax cable run quality
- Tests and grades splitter performance
- Measures length of coax cable in feet or meters
- Identifies up to 4 RF remotes and 12 ID Only Coax remotes
- Automatic pre-test voltage checks
- Measures single cable length up to 1,500 ft
- Tone generator with selectable tone cadence to easily trace cable runs
- Conserves power and supports long battery life with Auto-off feature and battery low icon
- Four AA alkaline batteries provided with your purchase

COAX CLARIFIER™ DESCRIPTION

The Coax Clarifier™, illustrated in Figure 1, has three main parts: the F-Connector, the LCD display screen, and the keypad.

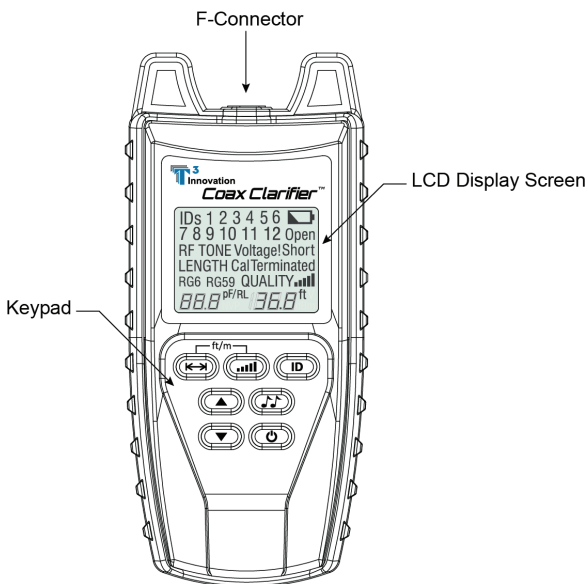

Figure 1. Coax Clarifier™

F-Connector

One F-Connector is located at the top of the Coax Clarifier™. The connector enables you to test and measure single cables and coax networks.

Note: An F-Connector coupler is provided with your purchase of the Coax Clarifier™.

LCD Display Screen

The Coax Clarifier™ has a high contrast, backlight LCD display screen, shown in Figure 2 below. The LCD display screen shows the following: cable conditions, test modes and related icons, calibration icon, voltage detected warning, active signal warning, and battery capacity.

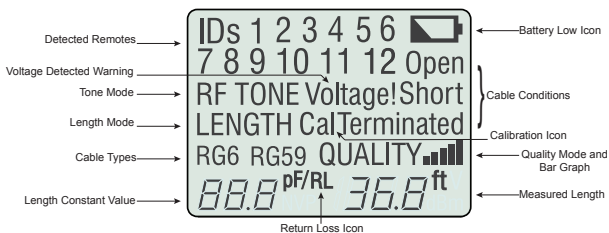

Figure 2. LCD Display Screen

Cable Conditions

The device checks for three cable conditions during testing: Open, Short, and Terminated. The cable conditions, explained in Table 5, appear in a column below the battery low icon in the LCD display screen.

Table 5. Cable Conditions

Cable Conditions	Description
Open	An "Open" error indicates a wire connection within the cable is not continuous throughout the length of the cable.
Short	The "Short" icon appears when the two wires within a cable are electrically connected. This is also known as a short circuit.
Terminated	The "Terminated" icon will appear when the far end of the run has an F-Terminator Plug in place or is wired to a device.

ID Mode

When the Coax Clarifier™ is set to ID Mode, the “ID” and “RF” icons appear in the top left corner of the LCD display screen. Table 6 describes the numbers and icons that appear in the display screen according to three testing scenarios.

Table 6. ID Mode Numbers and Icons

Test Scenario	Displayed Numbers and Icons
Detected Remotes	<p>Identified remotes 1-12 display in the top two rows of the LCD display screen.</p> <ul style="list-style-type: none">▪ When an ID Only Coax remote is detected, the “RF” icon disappears from view.▪ The “IdLE” icon appears in the lower right corner of the display screen when mapping is complete and all remotes are detected.
Unterminated Runs	<p>RF and ID Only Coax remotes are not identified on unterminated runs.</p> <ul style="list-style-type: none">▪ The “Open” icon appears in the right side of the display screen to indicate the network is unterminated.▪ The halt icon, “HLt”, displays in the right side of the screen demonstrating the unit is idle and the test was incomplete (see Figure 3).
Poor Network Quality	<p>ID mode does not function on a coax network with a poor quality reading (< 17 dB).</p> <ul style="list-style-type: none">▪ When the network quality is low, mapping stops, the “QUALITY” icon flashes, and the “HLt” icon appears in the lower right corner of the display screen (see Figure 4).

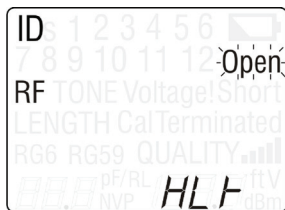

Figure 3. ID Mode with Unterminated Run



Figure 4. ID Mode with Poor Network Quality

Note: When the network quality is low, be sure that all cable ends are terminated. Unterminated cables result in signal loss. Use F-Terminator Plugs as needed to improve network quality.

Length Mode

The “Length” icon appears in the left side of the LCD display screen when the LENGTH button is pressed. When the unit is set to measure cable length, the length reading and measurement specifications described in Table 7 appear in the LCD display screen (see Figure 5).

Table 7. Length Mode Measurement Specifications

Length Specifications	Description
Cable Types	The cable types (RG6, RG59, or no specified type) appear in the lower left of the LCD display screen. <ul style="list-style-type: none">▪ Each type of cable has its own length constant value, which is used to properly measure cable length.
Length Constant Value	A value measured in picofarads (pF) per foot or meter appears in the lower left corner of the LCD display screen. This value corresponds to the selected cable type and can be adjusted at any time.
Measured Length	The length of the measured cable displays in units of feet or meters in the lower right corner of the screen.

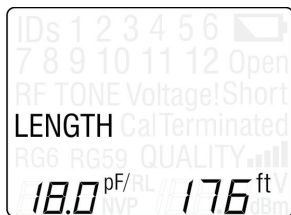

Figure 5. Length Measurement for Unspecified Cable

Note: Refer to the **Using Length Mode** section to learn how to change the unit of measurement, adjust the length constant value for each cable type, and measure cable length.

Quality Mode

When the QUALITY button is pressed the “Quality” icon displays in the lower right corner of the LCD display screen and a bouncing ball activity indicator is shown in the lower left corner of the screen. When testing network quality, the following icons and values appear in the screen (see Figure 6):

- **Bar Graph** – The bar graph depicts the overall quality of the network being tested. The bar graph, appearing in the lower right of the screen, corresponds to the measured return loss and will adjust (increasing or decreasing in the visual bars shown) as the return loss value fluctuates. Refer to the **Using Quality Mode** section for a description of what each bar represents in terms of network quality.
- **Return Loss (RL)** – When the unit produces a return loss value for the network quality, the “RL” icon appears to the left of the measured return loss value. Return loss is measured in dB and displays in the lower right corner of the screen.

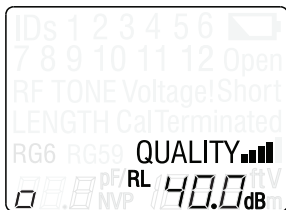

Figure 6. Return Loss Measurement in Quality Mode

Note: Using F-Terminator Plugs on unterminated cable ends will improve network quality and lower return loss.

Tone Mode

When the TONE button is pressed, the “Tone” icon appears in the middle of the LCD display screen and a bouncing ball activity indicator is shown in the lower left corner of the screen. The “RF” symbol will display to the left of the “Tone” icon when you set Tone Mode to measure the network’s insertion loss. When using Tone Mode, the icons and values described in Table 8 appear in the LCD display screen.

Table 8. Tone Mode Icons and Values

Icons and Values	Description
Tone Path Selection	The selected cadence is transmitted on the coax pin (“P”), the coax shield (“S”), or both the pin and shield (“PS”). <ul style="list-style-type: none">▪ The icons related to the current tone path selection appear in the lower left corner of LCD display screen.
Frequency	If the unit is set to measure network insertion loss, one of the following frequencies (measured in MHz) displays in the lower right corner of the screen: 10.0, 20.0, 30.0, or 40.0 (see Figure 7).
Cadence	If the unit is set to identify cable runs, one of the following tone options appears in the lower right corner of the display screen: HL1, HL2, Hi, and Lo (see Figure 8).

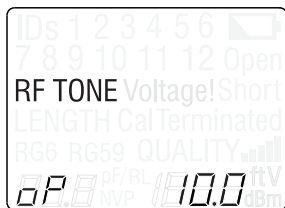

Figure 7. RF Tone with 10.0 MHz Frequency

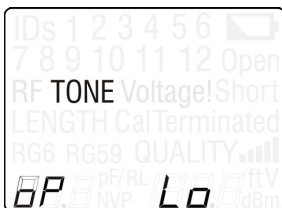

Figure 8. Tone Mode with Lo Cadence

Note: Refer to the **Using Tone Mode** section to learn how to run the two tone tests.

Cal

The “Cal” icon flashes in the middle of the LCD display screen when editing the length constant value in Length Mode and during calibration testing. The Coax Clarifier™ performs a calibration and self-test pass before starting Quality or ID testing.

If calibration fails, the “Cal” icon flashes to indicate that the unit failed to initialize properly. Hold down the POWER button to turn the unit off or press the test mode button again (QUALITY or ID) to proceed with testing.

Battery Low

The battery low icon appears when the battery is nearing depletion. The symbol flashes when there is 30 minutes of remaining battery life indicating the battery needs to be replaced. Results may be unreliable at this point.

Voltage Detected Warning (Voltage!)

If voltage is detected on the cable the “Voltage!” icon flashes. A check for voltage is performed before each test and during most tests when looping or changing test parameters. If voltage is detected, testing stops. If the icon appears, the Coax Clarifier™ should be immediately disconnected from the source of the voltage.

Active Signal Warning (Act Sig)

When an active signal is detected, the “Act Sig” message flashes at the bottom of the display screen. If an active signal is found, the unit should be immediately disconnected from the signal source. The Coax Clarifier™ will automatically turn off after 90 seconds if the unit is not disconnected from the active signal.

Keypad

The Coax Clarifier™ is equipped with seven buttons, illustrated in Figure 9. Four buttons, appearing in the top two rows of the keypad, are used to operate test modes (ID, Length, Quality, and Tone). Two Up/Down buttons are used to edit. One button is used to power the unit On/Off and toggle the backlight On/Off. The button functions are explained in Table 9.

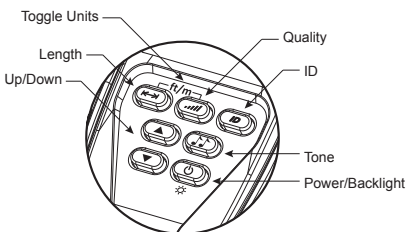





Figure 9. Keypad

Table 9. Keypad

Button	Function
Length 	<p>The Length Mode button is used to measure the length of a single, unterminated cable in feet or meters.</p> <ul style="list-style-type: none">▪ A short press of the Length and Quality buttons simultaneously toggles between length measurement units of feet and meters.▪ A long press (two seconds) of the Length button allows you to edit the length constant.
Quality 	<p>The Quality Mode button measures the overall quality of a coax network by measuring the network's return loss (calibrated in dB).</p> <ul style="list-style-type: none">▪ A short press of the button runs a loop test on the network every 30 seconds.
ID 	<p>The ID Mode button is used with ID Only Coax remotes and RF remotes to identify cable runs.</p> <ul style="list-style-type: none">▪ A short press of the ID button runs a single scan of the network.▪ ID Mode scans and identifies up to 4 RF remotes or 1-12 possible ID Only Coax remotes in the network.

Table 9. Keypad (Continued)

Button	Function
<p>Tone</p> 	<p>The Tone Mode button offers two types of testing: tone tracing (TONE) and measuring network insertion loss (RF TONE).</p> <p>TONE</p> <ul style="list-style-type: none"> ▪ A short press of the button transmits a 0 – 1 kHz cadence from the unit through the connected cable. ▪ Subsequent presses of the Tone button steps through the three tone path options (coax pin, coax shield, or coax pin and shield). <p>RF TONE</p> <p>Used to determine the network insertion loss (measured in dB) with the use of a compatible dB Loss meter.</p> <ul style="list-style-type: none"> ▪ A short press of the Tone button transmits a frequency from the unit through the connected cable.
<p>Up/Down</p>  	<ul style="list-style-type: none"> ▪ In Tone Mode, the Up and Down buttons allow you to select a tone test (TONE or RF TONE) and their respective cadence or frequency. ▪ In Length mode, the Up and Down buttons are used to select cable types and adjust (increment/decrement) length constant values.
<p>Power</p> 	<ul style="list-style-type: none"> ▪ A short press of the Power button enters Quality Mode. ▪ Short presses of any test mode button turns the unit On. ▪ Subsequent presses of the Power button toggle the backlight On and Off. ▪ A long press (two seconds) of the Power button turns the unit off.

OPERATIONS

To ensure safe operation of the Coax Clarifier™, follow the instructions carefully and pay attention to warning and caution symbols. Failure to observe warnings can result in severe injury or death and can damage the unit.

Turning the Unit On/Off

Turn Unit On

- Press any test mode button to turn the unit ON. The LCD display screen updates according to the test mode selected.

Turn Unit Off

- Press and hold down the POWER button for two seconds to turn the unit OFF. The display screen will go blank.

Automatic Power Down

The Coax Clarifier™ automatically turns off after a period of inactivity to conserve battery power. The automatic power down feature is dependent on which test modes are in use and if voltage is detected in the network (see Table 10).

Table 10. Automatic Power Down.

Test Mode	Time
Tone	60 minutes
Length	5 minutes
Quality	5 minutes
ID	5 minutes
Voltage Detected	90 seconds

Cable Testing General Guidelines

The Coax Clarifier™ tests several coax cable network parameters by measuring the overall network quality, determining the network's insertion loss, identifying cable runs by sound, locating remotes, and calibrating cable length.

Important Points to Note

- The unit should be OFF when you connect a cable.
- The F-Connector coupler must be affixed to the F-Connector on the top of the unit in order to properly connect cables.

Important Safety Points



The Coax Clarifier™ is designed for use on unenergized cabling systems. Connecting the Coax Clarifier™ to live AC power may damage the unit and pose a safety hazard for the user.



If the Voltage! icon appears, the Coax Clarifier™ should be disconnected immediately from the source of the voltage.



If an active signal is detected, the bottom of the LCD display screen flashes "Act Sig". Immediately disconnect the Coax Clarifier™ from the signal source. The unit turns OFF automatically after 90 seconds if it's not disconnected.

Using Tone Mode

Tone Mode offers two types of testing: tone tracing (TONE) and measuring network insertion loss (RF TONE). Setting the unit to TONE emits a cadence from the test unit through the connected cable. With the use of a tone probe, you can easily locate the cable carrying sound. Selecting RF TONE sends a frequency from the main test unit through the connected cable. The frequency is detected by a dB Loss meter, which calculates the network insertion loss.

Note: For the first use of Tone Mode, the unit is set to TONE for tone tracing. The tone path defaults to Pin (P) with frequency HL1. For subsequent uses of Tone Mode, the tone path and test last selected will be restored in the unit's memory.

Trace Cable Runs

In order to identify cables with the use of a tone probe, the Coax Clarifier™ must be set to TONE.

1. Connect one end of the coax cable to the F-Connector coupler on the unit.
2. Press the TONE button. The LCD display screen shows the following icons upon entering Tone Mode (see Figure 10):
 - The test last used (TONE or RF TONE).
 - A bouncing ball activity indicator in the lower left corner.
 - The tone path last selected: coax pin (P), coax shield (S), or both coax pin and shield (PS).
 - Cadence or frequency last selected.

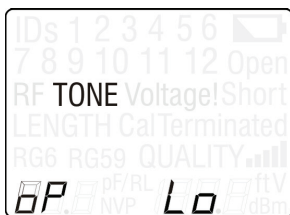

Figure 10. Tone Test with Lo Cadence and Coax Pin Selected

3. Select a cable-tracing cadence by pressing the UP and DOWN buttons until the display screen updates with the desired tone. There are four cadences to choose from: HL1, HL2, Hi, and Lo.



Whenever you change the cadence, the coax cable is tested for the presence of an active signal or voltage. If detected, the warnings display until the unit is disconnected from the voltage or active signal source. If the Coax Clarifier™ is not removed from the voltage or signal source, the unit turns OFF after 90 seconds.

4. Set the tone path (coax pin, coax shield, or coax pin and shield) by continuously pressing the TONE button until the tone path of your choosing updates in the LCD display screen.
5. Use the tone probe, according to the tone path selected, to identify cable runs.
6. Interpret display results and trouble-shoot potential cable conditions (Open, Short, or Terminated).
7. Press a different test mode button (LENGTH, QUALITY, or ID) to exit Tone Mode.

Measure Network Insertion Loss

The Coax Clarifier™ can measure point-to-point insertion loss (and gain) in a coax network by reporting the signal loss/gain value in terms of dB. This is accomplished by connecting the Coax Clarifier™ to one end of the network and a companion dB Loss meter to the end of a run in the network.

Note: *For best measurement accuracy, the cable network or individual splitter must be properly terminated. Use the F-Terminator plug accessory to terminate unused connections.*

Prepare Test Unit

1. Connect a coax cable to the F-Connector coupler on the unit.

- Press the TONE button. The LCD display screen shows the following icons upon entering Tone Mode:
 - The test last used (TONE or RF TONE).
 - A bouncing ball activity indicator in the lower left corner.
 - The tone path: coax pin (P), coax shield (S), or both coax pin and shield (PS).
 - Icons related to the tone test last used (frequency or cadence).
- Set the unit to RF TONE by pressing the UP and DOWN buttons until the LCD display screen updates with the RF TONE icon (see Figure 11).

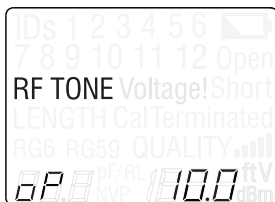

Figure 11. RF Tone Test with 10.0 MHz Frequency and Coax Pin Selected

- Select a frequency by pressing the UP and DOWN buttons until the LCD display screen updates with your desired selection. There are four RF Tone frequencies: 10.0 MHz, 20.0 MHz, 30.0 MHz and 40.0 MHz.

Note: *The insertion loss (signal loss) is typically greater at higher frequencies.*

Calibrate dB Loss Meter

Calibration is specific to the dB Loss meter being used. Follow the manufacturer's specifications to prepare the meter for measuring a coax network's insertion loss.

- Power up the dB Loss meter.
- Connect the Coax Clarifier™ to the dB Loss meter. Include in this connection any adapters and extension cables you would like to use

to perform the test. These accessories will not be included in the loss measurement reading.

3. When the dB Loss meter is calibrated to the network being tested, disconnect the meter from the Coax Clarifier™.

Measure Network Insertion Loss

1. Connect the Coax Clarifier™ to one end of the network and the dB Loss meter to the other end of the network. The dB Loss meter will show a loss/gain value, measured in dB, for the network at the selected frequency.

Note: *The measured insertion loss excludes any adapters or extension cables present during calibration.*

2. Measure the network insertion loss at the selected frequency (10.0 MHz, 20.0 MHz, 30.0 MHz, or 40.0 MHz).

Note: *Look for large insertion loss variations between frequencies at a single port. Any variation greater than 4 dB indicates a problem that requires investigation and resolution.*

Test Splitters

The Coax Clarifier™ and dB Loss meter can profile the quality of a network containing splitters.

Note: *Using F-Terminator Plugs on unterminated splitter outputs (or cable ends connected to the splitter) will improve network quality and lower dB loss.*

1. Connect the Coax Clarifier™ to the head of the network.
2. Run separate tests for each cable in the network.
 - a. Connect the dB Loss meter to the remote ends of the cables to measure the dB loss/gain at each remote point of the network.

- b. Test individual splitters by connecting the Coax Clarifier™ to the splitter input (cable run through the splitter) and connecting the dB Loss meter to the splitter outputs (cable(s) exiting the splitter).

Note: *With a multiple output splitter, you may need to connect the dB Loss meter to each cable exiting the splitter to verify that each output produces a good reading.*

3. Interpret display results and investigate any variation greater than 4 dB.

Using Length Mode

You can use Length Mode to measure the length of an unterminated cable. Do not use this test mode to measure a terminated cable's length. Measuring the length of a terminated cable run through splitters and/or other devices causes one or more of the following errors:

- The cable length is computed incorrectly showing an inflated length reading.
- The "Short" icon appears.
- The "Terminated" icon displays.
- If the unit is connected to a cable terminated with a 75 ohm resistor, the display reports the length as "---" and the "Short" icon appears.



When length is measured, the coax cable is tested for the presence of an active signal or voltage. If detected, a dynamic warning displays until the unit is disconnected from the voltage or active signal source. The Coax Clarifier™ automatically turns OFF after 90 seconds if the unit is not removed from the voltage or signal source.

Measure Cable Length

1. Connect one end of the coax cable to the F-Connector coupler on top of the unit.
2. Press the LENGTH button. The LCD display screen shows the following upon entering Length Mode (see Figure 12):
 - LENGTH icon appears.

- Cable type: RG6, RG59, or no specified cable type (the cable type field in the display screen will appear blank).
- Length constant value measured in pF (picofarads) per foot or per meter. The unit of measurement (feet or meters) defaults to the value last selected.
- Measured cable length in units of feet or meters appears in the lower right corner.
- A moving bar activity indicator above the measured cable length.



Figure 12. Measured Cable Length

3. Select the cable type by pressing the UP and DOWN buttons until the display screen updates with your desired cable type (RG6, RG59, or no specified cable type).

Note: *The cable type selected is restored the next time Length Mode is used.*

*Each cable type has its own length constant value for computing length. The Coax Clarifier™ comes with programmed length constant values for each cable type. The length constant values can be modified at any time. Refer to the **Adjust Length Constant Value** section for instructions on how to modify the length constant value.*

4. Quickly press the LENGTH and QUALITY buttons simultaneously to toggle the measurement units between feet and meters. The following updates appear on the display screen:
 - The length measurement reading adjusts to meters or feet in the lower right corner of the LCD display screen.

- The length constant value adjusts to the unit of measurement selected in the lower left corner of the screen.
- A moving bar activity indicator above the measured cable length remains on.

Note: *When the measurement is set to meters, the length is displayed fractionally in ½ meter increments up to 200 meters. Cables longer than 200 meters are displayed without a fractional measurement.*

5. Interpret display results and trouble-shoot potential cable conditions (Open, Short, or Terminated).
6. Press a different test mode button (QUALITY, ID, or TONE) to exit Length Mode.

Adjust Length Constant Value

Cables have a specified capacitance per foot (or meter). This is the length constant used to determine a cable's length. The Coax Clarifier™ comes with default length constant values for cable types RG59 and RG6 as well as a value for an unspecified coax cable. These values, shown in Table 11, are standard length constants. You can adjust the length constant value according to the specifications of the cable you are testing. Three values can be entered and saved in the Coax Clarifier™ for the three types of cables.

Note: *Bypass this section if the default values stored in the unit's memory satisfy the length constant values for the cables you are measuring.*

Table 11. Default Length Constant Values

Cable Type	Length Constant (picofarads per foot)
RG6	18.6 pf/ft
RG59	20.5 pf/ft
None	15 pf/ft

Note: The length constant value last set for each cable type is stored in the unit's memory. If you have not adjusted the length constant value for any or all cable types, the default values, shown in Table 11 above, will be stored in the unit's memory. The length constant can be adjusted at any time.

1. Verify the unit is set to the desired unit of measurement (feet or meters). To change the unit of measurement, quickly press the LENGTH and QUALITY buttons at the same time.

Note: The measured cable length and the length constant value changes to the unit of measurement selected.

2. Make sure the Coax Clarifier™ is set to the appropriate cable type. The length constant value is edited for only the specified cable type. To change the cable type, press the UP and DOWN buttons until the screen updates with the desired selection (RG59, RG6, or no specified cable type).
3. Hold down the LENGTH button for two seconds to enter Edit Mode in order to edit the length constant value. The LCD display screen shows the following icons (see Figure 13):
 - LENGTH icon displays indicating you are in Length Mode.
 - The cable type displays (RG6, RG59, or no specified cable).
 - The length constant value and the calibration icon ("Cal") blink, one after the other, demonstrating you are in Edit Mode.
 - The Edit icon ("Edt") appears in the lower right corner of the screen.
 - The measurement unit ("m" for meters or "ft" for feet) displays to the right of the "Edt" icon.

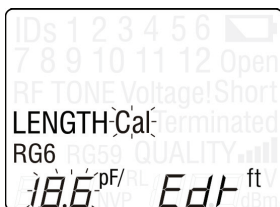

Figure 13. Adjusting Length Constant Value

4. Press the UP and DOWN buttons to increment or decrement the length constant value. The capacitance constant range is 10.0 pF/ft to 40.0 pF/ft (33 pF/m to 132 pF/m). Press and hold the UP or DOWN buttons to quickly increase or decrease the length constant value.

Note: *While editing, the measured cable length (shown in the lower right corner of the display screen) updates as you adjust the length constant value to reflect an accurate length reading computed with the latest length constant value.*

5. Press the LENGTH button to save the length constant, for the selected cable type, and exit Edit Mode. The adjusted length constant value will be stored in the unit's memory for the specified cable type.

Note: *Pressing other test mode buttons or the POWER button during Edit Mode will discard the edited value.*

6. Press a different test mode button (QUALITY, ID or TONE) to exit Length Mode.

Length Constant Accuracy

A signal cable acts as a capacitor with the capacitance proportional to the length of the cable. This constant of proportionality is known as the length constant and is measured in picofarads per foot or picofarads per meter. Length Measurement accuracy is dependent on how close the instrument can be set to the capacitance constant for the cable being measured.

The length constant can vary from cable to cable of the same type produced by the same manufacturer. It can also vary over the length of one cable because the length constant is dependent on the physical properties of the cable which may not be consistent throughout the entire length.

Using ID Mode

You can use ID Mode to identify RF remotes, for coax networks with splitters, and ID Only Coax remotes for individual coax cables. ID Only Coax remotes should not be used on coax networks.

Each RF remote has an LED light to indicate when the remote is responding to the main unit during testing. The LED light emits a single short flash when the RF remote is queried. RF remotes can only be used on a terminated network. The RF remotes can also be used as network terminators in Quality Mode.

If ID Mode is used on an unterminated network, the following icons can appear in the LCD display screen:

- If the network is completely unterminated, ID mapping is not possible. The "Open" icon flashes and the "HLT" icon displays in the lower-right corner of the LCD display screen (see Figure 14).
- If the network quality is low (<17dB), mapping stops, the "Quality" icon flashes, and the "HLT" icon appears in the lower right corner of the LCD display screen (see Figure 15).

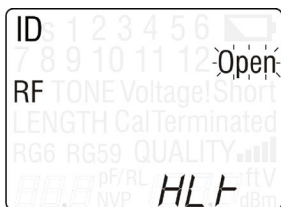



Figure 14. Unterminated Network Error



Figure 15. Poor Network Quality Error

Note: If the Quality value is low, this often means that cable ends are not terminated properly. Use F-Terminator Plugs on unterminated cable ends to improve network quality and operate ID mode successfully.

Make sure all connections are tight and secure before commencing testing. Loose connections will cause incorrect or intermittent readings.

 When ID mapping begins, the coax cable is tested for the presence of an active signal or voltage. A dynamic voltage warning is displayed until the detected voltage or active signal is removed. If not removed, the unit turns off automatically after 90 seconds.

1. Connect a coax cable to the F-Connector coupler on the unit.
2. Place ID Only Coax remotes or RF remotes on the far end of the cable.
3. Press the ID button to begin mapping the network. The LCD display screen shows the following icons upon entering ID Mode:
 - "ID" icon appears demonstrating you are in ID mode.
 - "RF" icon displays under the "ID" icon.

As mapping proceeds, a sequence of numbers is presented as each active remote is queried. When a remote is detected, it's number remains on and the following updates occur in the LCD display screen (see Figures 16 and 17):

- The "ID" icon remains on.
- The "RF" icon turns off when an ID Only Coax remote is detected or remains on when RF remotes are found.
- Identified remotes 1-12 display in the top two rows of the screen.
- The "Idle" icon appears in the lower right corner when mapping is complete.

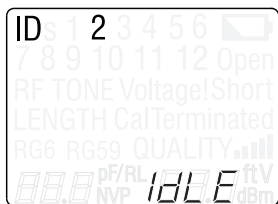

Figure 16. Detected ID Only Coax Remote

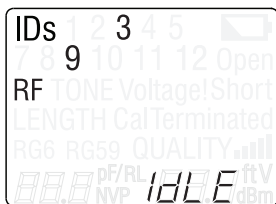

Figure 17. Detected RF Remote

4. Press the ID button again to run another scan of the network. ID mapping runs once when the ID button is pressed. Subsequent presses of the ID button execute additional scans of the network.
5. Interpret display results and trouble-shoot potential cable conditions (Open, Short, or Terminated).
6. To exit ID mapping, press a different test mode button.

RF Remote Battery Life

Each RF remote features a small LED light that indicates when the battery is nearing depletion and if the remote is responding to the test unit. When the battery voltage goes below the low battery threshold, the LED light blinks once every two seconds for approximately four minutes indicating the battery needs to be replaced. The battery check is only performed when the remote is activated for an ID test. Results may be unreliable once the battery low threshold is detected.

***Note:** Refer to the **RF Remote Battery Replacement** section for instructions on changing an RF remote's battery.*

Using Quality Mode

You can use Quality Mode to determine the overall network quality including all the network connections and branches. The Coax Clarifier™ reports the return loss as a number from 0.0 dB to 40.0 dB, with 40.0 being the best attainable quality. Follow instructions carefully to achieve an accurate network quality reading.

The measured network quality is depicted as a bar graph, appearing in the lower right corner of the LCD display screen. Each bar represents a range in dB that corresponds to the measured return loss. Table 12 explains the bar graph reading.

Table 12. Network Quality Bar Graph

Number of Bars	Network Quality (dB)
0	0 – 9.9 dB
1	10.0 - 19.9 dB
2	20.0 - 26.9 dB
3	27.0 - 32.9 dB
4	33.0 - 39.9 dB
5	40.0 dB +

In order to measure the return loss, the network must be terminated. If the network being measured is unterminated, the “Open” icon flashes and the return loss cannot be calculated. Use F-Terminator Plugs or RF remotes on cable ends to improve network quality.

RF Remotes and Network Quality

RF remotes have additional circuitry that is sensitive to very large signals, causing a potential degradation in the network quality reading when used as a network terminator in Quality Mode. With a 2-way splitter, about 3.5 dB attenuation, there is approximately a 15% reduction in the quality reading. If the Coax Clarifier™ signal has an attenuation of 6dB or higher in the path to the RF remotes, the quality reading will remain the same regardless of using a passive terminator or an RF remote.

For the most accurate quality readings in very low attenuation systems, a 75 ohm terminator should be used for terminations. In most cases, either a 75 ohm terminator or a RF remote may be used to terminate the system and will produce reliable quality reading results.

Measure Network Quality



Each time network quality is measured, the coax cable is tested for the presence of an active signal or voltage. If detected, a dynamic warning displays until the unit is disconnected from the voltage or signal source. If the Coax Clarifier™ is not disconnected, the unit turns off automatically after 90 seconds.

1. Connect one end of the coax cable into the F-Connector coupler.
2. Press the QUALITY button to measure the network's return loss. The LCD display screen shows the following icons upon entering Quality Mode (see Figure 18):
 - A bouncing ball activity indicator appears in the lower left corner.
 - The "QUALITY" icon appears.
 - The network return loss, measured in dB, appears in the lower right corner of the LCD display screen.
 - A bar graph appears above the return loss reading to visually depict the network's quality.

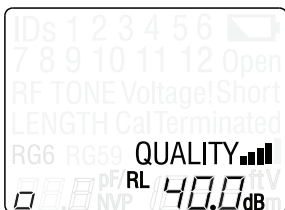

Figure 18. LCD Display Screen in Quality Mode

Note: The Quality test runs in a continuous loop. The return loss value is updated every ½ second.

3. Interpret display results and trouble-shoot potential cable conditions (Open and Short).
4. Press a different test mode button (LENGTH, ID or TONE) to exit Quality Mode.

MAINTENANCE

Coax Clarifier™ Battery Replacement

1. Remove the single screw on the battery door, located in the back of the Coax Clarifier™ towards the bottom of the unit, with a #1 Philips head screwdriver.
2. Take off the battery door and remove old batteries.
3. Replace with four AA Alkaline batteries. Slide batteries into the battery cartridge according to the diagram imprinted on the bottom of the battery compartment.
4. Return the battery door to the unit and tighten the screw to secure the battery door.



Do not over tighten the battery door. Doing so can damage the test unit.

RF Remote Battery Replacement

1. Remove screw on the bottom of the remote with a #1 Philips head screw driver
2. Take off the bottom cover and remove battery. You may need to push the battery out of the coin cell holder from the back side of the battery with the use of a small screw driver.
3. Insert the new battery, type CR2032, into the slot. The side of the battery marked by a positive "+" symbol should be placed towards the metal holder so the negative side of the battery faces the printed circuit board.
4. Replace bottom cover and insert screw. Do not over tighten.

Cleaning

Use a damp, clean cloth to clean the test unit.



Disconnect all cables from the Coax Clarifier™ prior to cleaning. Failing to do so can damage the unit and result in personal injury.

Do not use abrasive, harsh cleaners, or solvents to clean the Coax Clarifier™.

Storage

When the Coax Clarifier™ is not in use, store in a dry, protective case. The batteries should be removed if the unit is stored for a long period of time.



*Do not expose the Coax Clarifier to high temperatures or humidity. When stored in temperatures exceeding the limits listed in the **Specifications** section, allow the Coax Clarifier to return to the normal recommended operating conditions prior to use.*

CUSTOMER SERVICE

Contacting T3 Innovation

For technical information and customer support, please visit www.t3innovation.com or send an email to support@t3innovation.com.

Contact Numbers: Phone: 805-233-3390
Fax: 805-383-4507

Address: 808 Calle Plano
Camarillo, CA 93012

Additional Accessories and Kits

Table 13 lists the pouches provided in the four kits. These pouches are used to carry your Coax Clarifier accessories. Table 14 details the number of accessories provided in each kit and their respective product numbers. All kits contain the Coax Clarifier. Contact T3 Innovation for more information.

Table 13. Additional Accessories

Accessory	Product Number	Description
	CP100	Hanging T3 Pouch
	CP200	T3 Zipped Compartmentalized Pouch

Table 14 Coax Clarifier™ Kits

Kit CC200		
Product Number	Quantity	Description
CR001	1	No. 1 Coax RF Remote
CR002	1	No. 2 Coax RF Remote
RK104	1	Nos. 1 - 4 ID Only Coax Remote Set in Foam Holder
CA004	1	Cable Assembly, Screw-On F-Jack to Push-On F-Plug Cable - 12"
AD002	1	Adapter, F-Jack to BNC Jack
AD003	3	Adapter, F-Jack to Push-On Plug
AD004	3	F-Connector Coupler, F81
AD005	4	F-Terminator Plug
CP100	1	Hanging T3 Pouch
Kit CC210		
Product Number	Quantity	Description
CR001	1	No. 1 Coax RF Remote
CR002	1	No. 2 Coax RF Remote
CR003	1	No. 3 Coax RF Remote
CR004	1	No. 4 Coax RF Remote
RK104	1	Nos. 1 - 4 ID Only Coax Remote Set in Foam Holder
CA004	1	Cable Assembly, Screw-On F-Jack to Push-On F-Plug Cable - 12"
AD002	1	Adapter, F-Jack to BNC Jack
AD003	5	Adapter, F-Jack to Push-On Plug
AD004	5	F-Connector Coupler, F81
AD005	4	F-Terminator Plug
CP100	1	Hanging T3 Pouch

Kit CC220

Product Number	Quantity	Description
CR001	1	No. 1 Coax RF Remote
CR002	1	No. 2 Coax RF Remote
CR003	1	No. 3 Coax RF Remote
CR004	1	No. 4 Coax RF Remote
RK112	1	Nos. 1 - 12 ID Only Coax Remote Set in Foam Holder
CA004	1	Cable Assembly, Screw-On F-Jack to Push-On F-Plug Cable - 12"
AD002	1	Adapter, F-Jack to BNC Jack
AD003	5	Adapter, F-Jack to Push-On Plug
AD004	5	F-Connector Coupler, F81
AD005	4	F-Terminator Plug
CP100	1	Hanging T3 Pouch

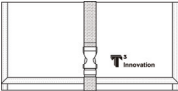
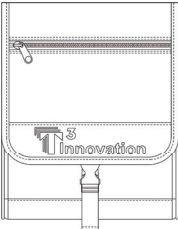
Kit CC250

Product Number	Quantity	Description
CR001	1	No. 1 Coax RF Remote
CR002	1	No. 2 Coax RF Remote
CR003	1	No. 3 Coax RF Remote
CR004	1	No. 4 Coax RF Remote
TP200	1	TrakAll Tone and Probe
RK112	1	Nos. 1 - 12 ID Only Coax Remote Set in Foam Holder
CA004	1	Cable Assembly, Screw-On F-Jack to Push-On F-Plug Cable - 12"
AD002	1	Adapter, F-Jack to BNC Jack
AD003	5	Adapter, F-Jack to Push-On Plug
AD004	5	F-Connector Coupler, F81
AD005	4	F-Terminator Plug
CP200	1	T3 Zipped Compartmentalized Pouch

Warranty Information

T3 Innovation guarantees that its products will be free of all defects in material and workmanship. This warranty extends for a period of 12 months for the T3 Innovation test equipment from the date of manufacture or proof-of-purchase.

All products deemed defective under this warranty will be repaired or replaced at T3 Innovation's discretion. No further warranties either implied or expressed will apply, nor will responsibility for operation of this device be assumed by T3 Innovation.

Product Registration

Registration of your purchased equipment and accessories allows you to access support information and receive notifications of product updates. To register products, please visit the T3 Innovation website at www.t3innovation.com/warranty.

Disposal

 WEEE Compliant: Prior to disposal of this product, please contact T3 Innovation for proper disposal options.

Returns

Prior to returning any product to T3 Innovation, you must first request a Return Merchandise Authorization Number by contacting the Customer Service Department at 805-233-3390.

Note: *Shipments will not be accepted without this number, which must be clearly marked on the shipping label.*

1. Prior to packing, include a copy of the sales receipt if available.
2. Provide a description of the operational problem with the product(s) being returned.
3. Include a contact name, phone number, and e-mail address.
4. Pack items securely to prevent damage during shipping.
5. Ship prepaid to: T3 Innovation
808 Calle Plano
Camarillo, CA 93012

SPECIFICATIONS

Physical Dimensions	Size: 17.3 x 8.0 x 3.3 cm (6.8 x 3.15 x 1.3 inches) Weight: 340 grams (12.0 oz.) with battery
Power	4 AA alkaline batteries <ul style="list-style-type: none">▪ Standby: 4 years▪ Active: 20 hours average
Operating Environment	<ul style="list-style-type: none">▪ Operating temperature: 0 to 50 °C (32 to 122 °F)▪ Storage temperature: -20 to 60 °C (-4 to 140 °F)▪ Humidity: 10% to 90%, non-condensing▪ Altitude: 3,050 meters (10,000ft) maximum
Quality (Return Loss)	0.0 to 40.0dB
ID Only Coax Remotes	100 ohms maximum DC resistance, center conductor plus shield
Coax RF Remotes	17 dB maximum attenuation to remote location (splitters, cable, etc.)
Audio Frequency Tone	<ul style="list-style-type: none">▪ 1,000 and 600 Hz – 4 patterns (High only, Low only, 2 warble tones)▪ 3.3Vp-p (pin or shield), 6.6Vp-p (both pin and shield) open circuit
Radio Frequency Tone	10, 20, 30 or 40MHz, 1Vrms into 75 ohms
Battery Low Level	Approximately 4 volts
Capacitance Length	<ul style="list-style-type: none">▪ Range – 0 to 1,500 ft (457 meters) min at 15pF/ft length constant▪ Accuracy – $\pm 5\%$ ± 1ft (0.5 m) with correct length constant▪ Length Constant Range – 10.0 to 40.0 pF/ft (33 to 131pF/meter)
Compliance	 Complies with Conformité Européenne directives.

Coax Clarifier™

Test. Identify. Qualify.

User Manual



For technical information and customer support,
please visit www.t3innovation.com or send an
email to support@t3innovation.com.

Contact Numbers: Phone: 805-233-3390
Fax: 805-383-4507

Address: 808 Calle Plano
Camarillo, CA 93012

www.t3innovation.com